

YARWAY COLOR-PORT® WATER LEVEL GAUGES

Bi-color, direct reading, ported style water level gauge for low, medium and high pressure boilers



GENERAL APPLICATION

Color-Port gauges provide continuous indication of boiler water levels as required by the ASME Boiler and Pressure Code PG-60.

FEATURES

- Combination of design and durable materials assures long service life.
- Individual port assemblies can be replaced in minutes with the gauge in place.
- Spring loading maintains proper pressure on glasses and gaskets at all times.
- Contrasting red and green readings show water level through high visibility illuminator display view slots.
- Choice of direct or mirror viewing systems.
- Choice of low, medium or high pressure designs for use with stuffing box gaug cocks or Welbloc L200V valves.
- Glasses accurately molded and tempered to high specifications.
- Glass, mica and gasket assembly is registered precisely in the body's gasket groove.
- High quality mica protects the inner surface of each glass from the erosive action of steam, water and alkalis.
- Specially-molded flexible graphite gasket between mica and gauge body ensures a tight seal.
- PED 97/23/EC conformance available.

TECHNICAL DATA

Sizes:	½" to ¾" (15 to 19 mm)
Max. pressure	
Low pressure design:	850 psi (59 bar)
Medium pressure design:	1800 psi (124 bar)
High pressure design:	3000 psi (207 bar)
Number of ports:	5 to 26
Visibility:	12-3/16" to 72-9/16" (310 to 1843 mm)

YARWAY™

16633 Foltz Parkway, Strongsville, OH 44149 USA • Telephone: +440-572-1500
www.PenberthyProcess.com • sales@PenberthyProcess.com

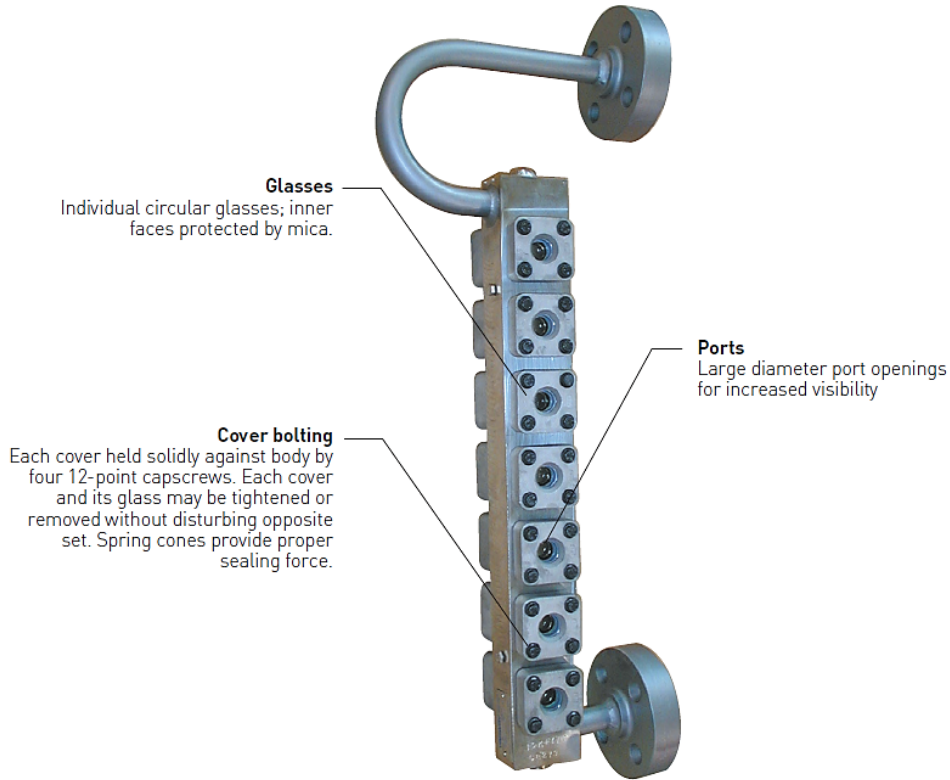

PG-60.1 WATER LEVEL INDICATORS

Color-Port gauges provide continuous indication of boiler water levels as required by the ASME* Boiler and Pressure Code. Under PG-60, the Code states:

PG-60.1: all boilers having a fixed water level (steam and water interface) shall have at least one gauge glass (a transparent device that permits visual determination of the water level).

PG-60.1.1: boilers having a maximum allowable working pressure exceeding 400 psi (2800 kPa) shall have two gauge glasses. Instead of one of the two required gauge glasses, two independent remote water level indicators (two discrete systems that continuously measure, transmit, and display water level) may be provided. Boilers not having a fixed water level, such as forced-flow steam generators and high-temperature water boilers of the forced circulation type, are not required to have a gauge glass. Electrode type electric boilers are required to have only one gauge glass, regardless of MAWP.

PG-60.1.1.1: when the water level in at least one gauge glass is not readily visible to the operator in the area where control actions are initiated, either a fiber optic cable (with no electrical modification of the optical signal) or mirrors shall be provided to transfer the optical image of the water level to the control area. Alternatively, any combination of two of the following shall be provided: (a) an independent remote water level indicator; (b) an independent continuous transmission and display of an image of the water level in a gauge glass.

*The American Society of Mechanical Engineers, Boiler and Pressure Vessel Committee, establishes rules of safety governing the design, fabrication and inspection of boilers and unfired pressure vessels.

YARWAY COLOR-PORT® WATER LEVEL GAUGES

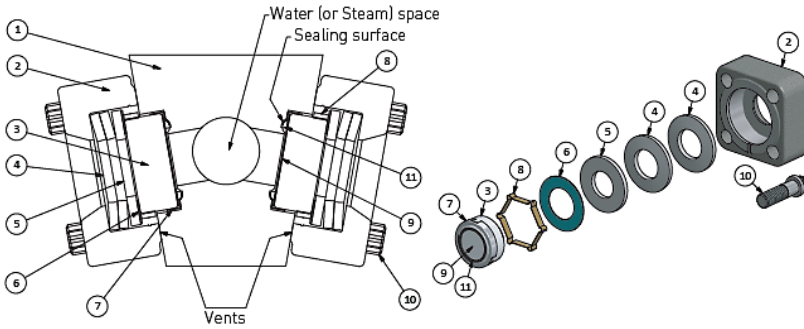

Item No.	Part Name
1	Gauge Body
2	Cover
3	Glass*
4	Spring Cones
5	Washer
6	Cushion Gasket*
7	Clip Ring*
8	Retaining Spring
9	Mica*
10	Cap Screws
11	Sealing Gasket*

*Furnished in kit - P/N 7Y584-000

Groove clean up tool - (stainless wire brush) P/N 301160

A complete Color-Port system includes the gauge, a water column or tie bar, two gauge valves and an illuminator/display.

Illuminators

Illuminators are designed to be mounted readily to the color-port gauge chamber and comprise three main components: level display, illuminator and power supply. An LED lighting source is standard.

All illuminators are complete with a color screen containing two strips of glass – one red and one green. Due to the difference in the index of refraction of light through water and steam, only the corresponding color is seen: green for water, red for steam.

Functioning illumination and hoods are required on all Ported Gages to meet ASME BPVC Section I requirements.

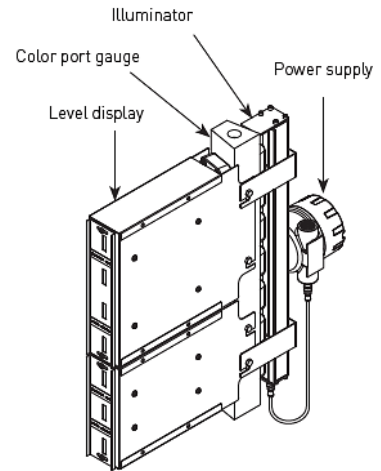

LED PORTED GAUGE ILLUMINATOR AND LEVEL DISPLAY

SHOWING STEAM PRESENT

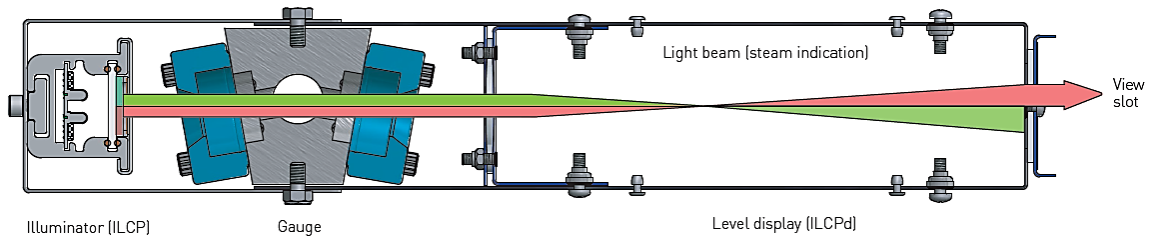

SHOWING WATER PRESENT

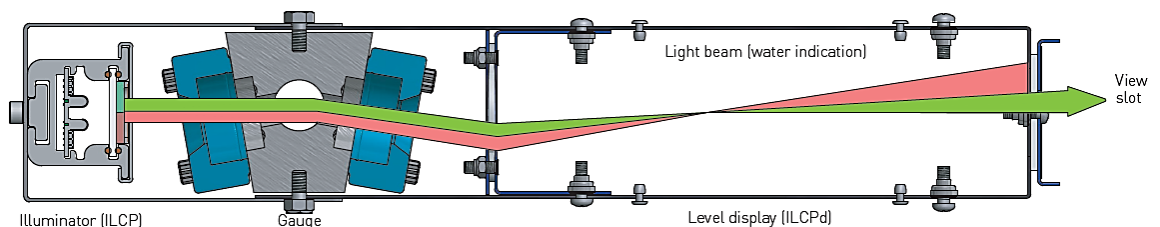



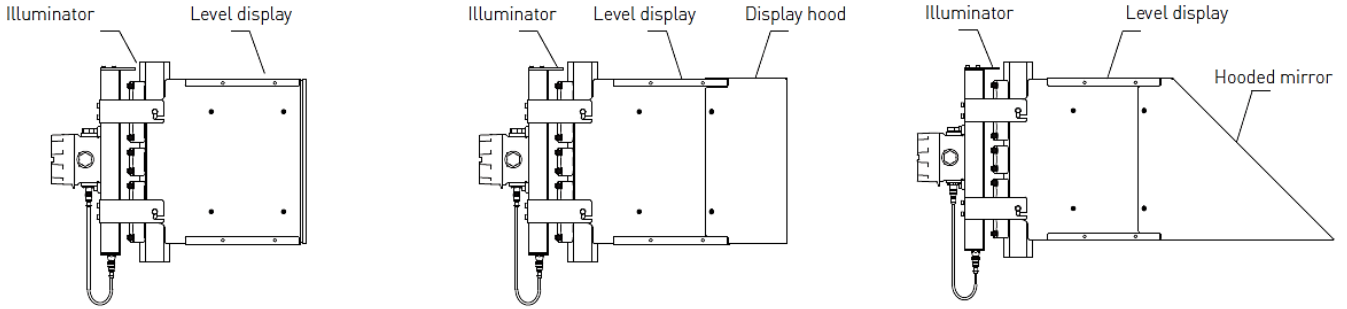



TYPICAL VIEWING SYSTEMS

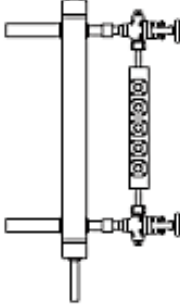
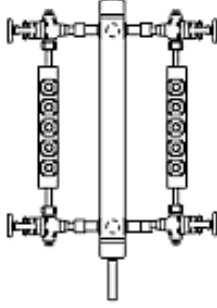

Features and benefits

- Meets ASME Boiler Code requirements for direct gauge viewing.
- Up to 100,000 hours service.
- Design to be assembled and disassembled from the gauge easily.
- Power supply housed in an aluminum explosion-proof housing with 3/4" NPTF electrical connection
- Input voltage 115 or 230 VAC at 50-60 Hz.
- Power consumption up to 400 mA max at 115 / 230 V AC.
- Power supply can be mounted integrally or remote mounted up to 200 feet from illuminator. Consult factory for longer distance requirements.

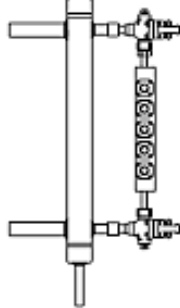
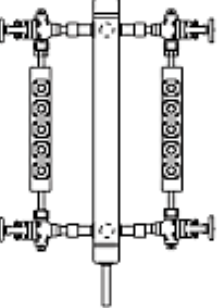
COLOR-PORT GAUGE COLUMN CHARTS

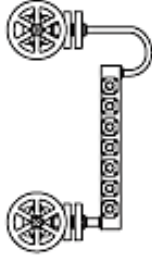
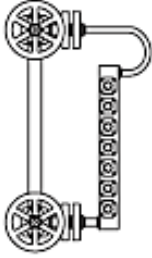
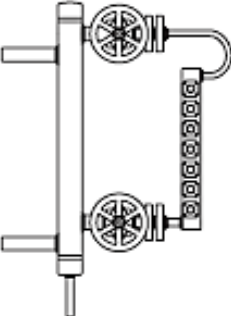
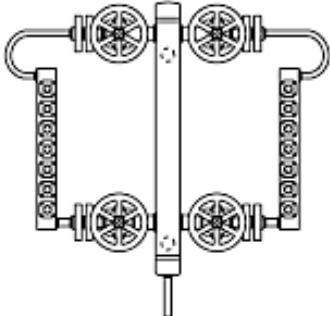
850 psi (59 bar)	 <p>4511N</p>	 <p>4511N w/780 gaugecocks</p>	 <p>4511N w/780 gaugecocks assembled to column</p>	 <p>Dual 4511N w/780 gaugecocks assembled to column</p>
1800 psi (124 bar)	 <p>4511N w/spacer</p>	 <p>4511N w/spacer and 780 gaugecocks</p>	 <p>4511N w/spacer and 780 gaugecocks assembled to column</p>	 <p>Dual 4511N w/spacer and 780 gaugecocks assembled to column</p>
3000 psi (207 bar)	 <p>4595F</p>	 <p>4595FG</p>	 <p>4595F w/Welbloc L200V</p>	 <p>4595F w/Welbloc L200V and circulating tie bar</p>
3000 psi (207 bar)	 <p>4595F w/Welbloc L200V assembled to column</p>		 <p>Dual 4595F w/Welbloc L200V assembled to column</p>	

STANDARD INSTALLATION ARRANGEMENTS

Wide range of assemblies

Various assemblies and visibilities are available with low, medium or high pressure gauges by using single or multiple gauges and various columns.

How to order Color-Port gauges

For proper Color-Port gauge assembly, pressure, visibility and gauge connections consult selection and visibility charts.

When ordering a separate replacement gauge, provide the serial number of the existing gauge.

Other gauge glass availability

Medium and high pressure flat glass gauges as well as low pressure (250 psi to 650 psi) armored transparent and reflex gauges are available.

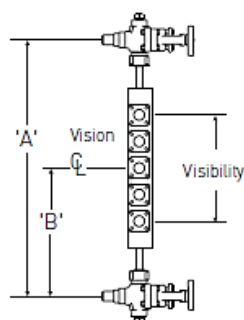

4511N/780 up to 850 psig

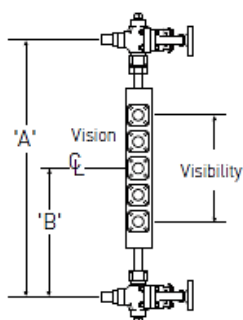

4511N/780 with spacer up to 1800 psig

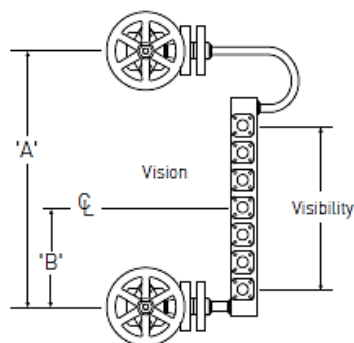

4595F/Welbloc L200V up to 3000 psig

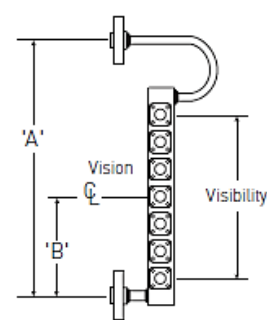

495FG up to 3000 psig

VISIBILITY CHART, inches (mm)

	12.188 (310)	15.063 (383)	17.938 (456)	20.813 (529)	23.688 (602)	26.563 (675)	29.438 (748)	32.313 (821)	35.188 (894)	38.063 (967)	40.938 (1040)
Visibility											
No. of ports	5	6	7	8	9	10	11	12	13	14	15
4511N with 780 gaugecocks - up to 850 psi (59 bar)											
Dimension 'A'	24.75	27.625	30.5	33.375	36.25	39.125	42	44.875	47.75	50.625	53.5
Minimum	[629]	[702]	[775]	[848]	[921]	[994]	[1067]	[1140]	[1213]	[1286]	[1359]
Dimension 'B'	12.375	13.813	15.25	16.688	18.125	19.563	21	22.438	23.875	25.313	26.75
Minimum	[314]	[351]	[387]	[424]	[460]	[497]	[533]	[570]	[606]	[643]	[679]
4511N with 780 gaugecocks and spacer - up to 1800 psi (124 bar)											
Dimension 'A'	25.125	28	30.875	33.75	36.625	39.5	42.375	45.25	48.125	51	53.875
Minimum	[638]	[711]	[784]	[857]	[930]	[1003]	[1076]	[1149]	[1222]	[1295]	[1368]
Dimension 'B'	12.563	14	15.438	16.875	18.313	19.75	21.188	22.625	24.063	25.5	26.938
Minimum	[319]	[356]	[392]	[429]	[465]	[502]	[538]	[575]	[611]	[648]	[684]
4595F with Welbloc L200V valves - up to 3000 psi (207 bar)											
Dimension 'A'	20.25	23.125	26	28.875	31.75	34.625	37.5	40.375	43.25	46.125	49
Minimum	[514]	[587]	[660]	[733]	[806]	[879]	[953]	[1026]	[1099]	[1172]	[1245]
Dimension 'B'	7.625	9.063	10.5	11.938	13.375	14.813	16.25	17.688	19.125	20.563	22
Minimum	[194]	[230]	[267]	[303]	[340]	[376]	[413]	[449]	[486]	[522]	[559]
4595FG with Welbloc L200V valves - up to 3000 psi (207 bar)											
Dimension 'A'	17.5	20.375	23.25	26.125	29	31.875	34.75	37.625	40.5	43.375	46.25
Minimum	[445]	[518]	[591]	[664]	[737]	[810]	[883]	[956]	[1029]	[1102]	[1175]
Dimension 'B'	7.625	9.063	10.5	11.938	13.375	14.813	16.25	17.688	19.125	20.563	22
Minimum	[194]	[230]	[267]	[303]	[340]	[376]	[413]	[449]	[486]	[522]	[559]

VISIBILITY CHART, inches (mm) (continued)

Visibility	43.813 (1113)	46.688 (1186)	49.563 (1259)	52.438 (1332)	55.313 (1405)	58.188 (1478)	61.063 (1551)	63.938 (1624)	66.813 (1697)	69.688 (1770)	72.563 (1843)
No. of ports	16	17	18	19	20	21	22	23	24	25	26
4511N with 780 gaugecocks - up to 850 psi (59 bar)											
Dimension 'A'	56.375 (1432)	59.25 (1505)	62.125 (1578)	65 (1651)	67.875 (1724)	70.75 (1797)	73.625 (1870)	76.5 (1943)	79.375 (2016)	82.25 (2089)	85.125 (2162)
Minimum	28.188 (716)	29.625 (752)	31.063 (789)	32.5 (826)	33.938 (862)	35.375 (899)	36.813 (935)	38.25 (972)	39.688 (1008)	41.125 (1045)	42.563 (1081)
4511N with 780 gaugecocks and spacer - up to 1800 psi (124 bar)											
Dimension 'A'	56.75 (1441)	59.625 (1514)	62.5 (1588)	65.375 (1661)	68.25 (1734)	71.125 (1807)	74 (1880)	76.875 (1953)	79.75 (2026)	82.625 (2099)	85.5 (2172)
Minimum	28.375 (721)	29.813 (757)	31.25 (794)	32.688 (830)	34.125 (867)	35.563 (903)	37 (940)	38.438 (976)	39.875 (1013)	41.313 (1049)	42.75 (1086)
4595F with Welbloc L200V valves - up to 3000 psi (207 bar)											
Dimension 'A'	51.875 (1318)	54.75 (1391)	57.625 (1464)	60.5 (1537)	63.375 (1610)	66.25 (1683)	69.125 (1756)	72 (1829)	74.875 (1902)	77.75 (1975)	80.625 (2048)
Minimum	23.438 (595)	24.875 (632)	26.313 (668)	27.75 (705)	29.188 (741)	30.625 (778)	32.063 (814)	33.5 (851)	34.938 (887)	36.375 (924)	37.813 (960)
4595FG with Welbloc L200V valves - up to 3000 psi (207 bar)											
Dimension 'A'	49.125 (1248)	52 (1321)	54.875 (1394)	57.75 (1467)	60.625 (1540)	63.5 (1613)	66.375 (1686)	69.25 (1759)	72.125 (1832)	75 (1905)	77.875 (1978)
Minimum	23.438 (595)	24.875 (632)	26.313 (668)	27.75 (705)	29.188 (741)	30.625 (778)	32.063 (814)	33.5 (851)	34.938 (887)	36.375 (924)	37.813 (960)

GAUGE ACCESSORIES

Gauge valves

780 gaugecocks are designed to be used with stuffing box type (nipple end) low and medium pressure gauges (up to 1800 psi, 124 barg) to isolate the gauges from the pressure vessel when it becomes necessary to drain and service them. These models feature:

- Outside screw and yoke.
- A vertical rising lower and horizontal leaky upper ball check shut-off.
- An offset pattern that allows the inside of the gauge glass to be cleaned easily with a minimum of disassembly.
- Solid shank vessel connection (NPT, Socketwelding or flanged ends).
- Threaded renewable seat and backseating stem.

Welbloc L200V type gauge valves are designed to be used with flanged end high pressure gauges (up to 3000 psig, 207 barg). Welbloc L200V gauge valves feature a Stellite disc and integral Stellite seat. Internals are completely accessible with the valve connected in the line.

Chain and line pulls are available for 780 and Welbloc L200V gauge valves.

Drain connections

780 stuffing box gaugecocks: 1/2" and 3/4" NPTF and socketwelding available; located on lower gaugecock.

Welbloc L200V gauge valves: 3/4" socketweld connection located at bottom on lower valve block.

Water columns: 3/4" socketweld connection located at bottom of column.

Tie bar: 3/4" socketweld connection located at bottom of tie bar assembly.

780 upper stuffing box gaugecock (side view)

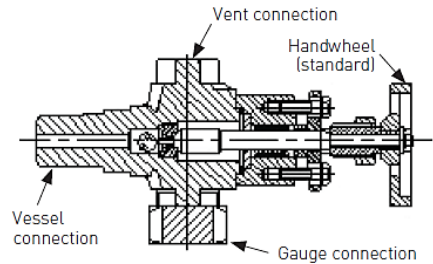

Upper Welbloc L200V gauge valve (Left hand plan view shown)

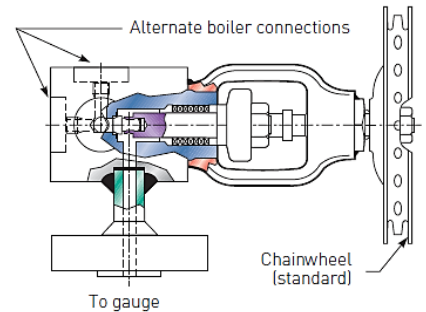

Determining gauge valve 'hand': when facing chain wheels, valve is left hand when gauge is on your left; valve is right hand when gauge is on your right.

GAUGE ACCESSORIES

Ball check shut off

Series Hy-P ball checks are designed for high pressure applications (up to 3000 psig, 207 barg) to limit the flow of process fluid due to sudden downstream pressure loss such as glass breakage. The benefit of the ball check is to safeguard personnel and property from the sudden escape of high pressure steam or water. These models are supplied in pairs (upper and lower) with a vertical rising ball for the lower mount application and a horizontal ball with leaky seat for upper mounting to meet ASME Boiler and Pressure Vessel Code Section I applications.

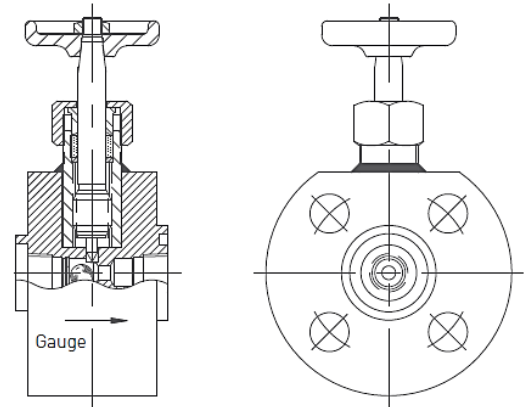
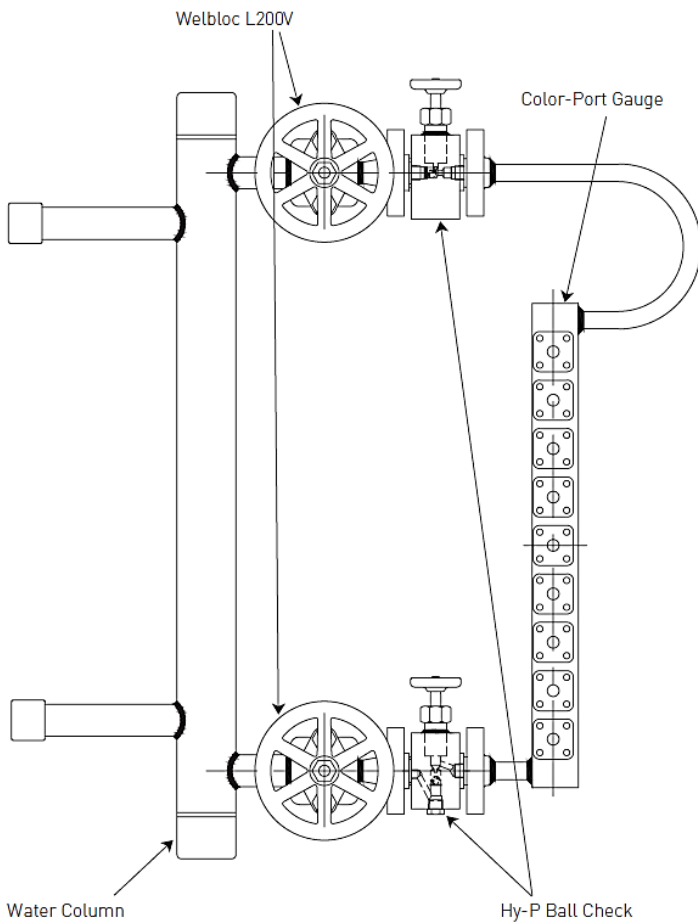

Series HY-P upper ball check

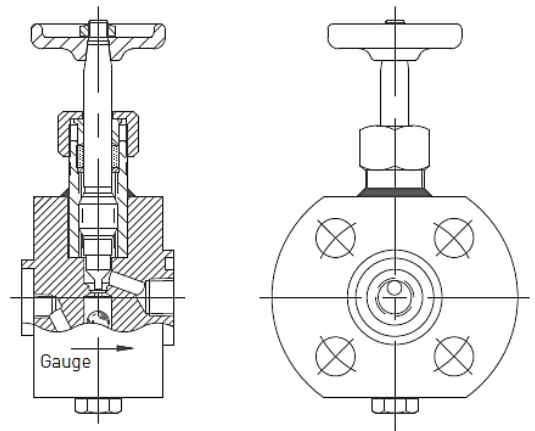

Series HY-P lower ball check

Authorised Distributor:



**NATIONWIDE
OIL & GAS**

46, Jalan SS 22/21, Damansara Jaya,
47400 Petaling Jaya,
Selangor Darul Ehsan, Malaysia.
Email: nog@nog.com.my
Website: www.nog.com.my

YARWAY™

16633 Foltz Parkway, Strongsville, OH 44149 USA • Telephone: +440-572-1500
www.PenberthyProcess.com • sales@PenberthyProcess.com